

Universal  
Components  
Inc.



Gauges



# ANSI/ASME B40.1

## HIGHLIGHTS of ANSI/ASME B40.1

### INSTALLATION:

GAUGE SHOULD BE INSTALLED BY TIGHTENING THE PRESSURE CONNECTION USING THE WRENCH FLATS PROVIDED. FAILURE TO DO SO MAY RESULT IN LOSS OF ACCURACY AND/OR MECHANICAL DAMAGE

### OPERATING PRESSURE:

THE OPERATING PRESSURE SHOULD OCCUR IN THE MIDDLE HALF (25%-75%), OF THE FULL SCALE PRESSURE OF THE GAUGE SELECTED. THE OPERATING PRESSURE SHOULD BE HALF OF THE FULL PRESSURE OF THE GAUGE

### OVER PRESSURE FAILURE:

WHEN VALVES OPEN OR CLOSE, SHORT DURATION PRESSURE IMPULSES MAY BE MANY TIMES THE NORMAL OPERATING PRESSURE AND MAY NOT BE INDICATED BY THE GAUGE. THE RESULT COULD BE IMMEDIATE FAILURE OR LOSS OF ACCURACY. OPERATING PRESSURE SHOULD NEVER EXCEED 75% OF FULL SCALE.

### VIBRATION FAILURE:

VIBRATION OR HIGH CYCLIC LOADING WILL CAUSE GRADUAL LOSS OF ACCURACY AND FAILURE OF THE POINTER. IT MAY ALSO CAUSE CRACKS IN THE ELEMENT OR JOINTS WHICH COULD RESULT IN A FAILURE SIMILAR TO AN EXPLOSIVE FAILURE. PRESSURE SNUBBERS AND GLYCERINE FILLED GAUGES ARE RECOMMENDED IN THESE APPLICATIONS.

### WARNING:

MISUSE OF PRODUCT MAY CAUSE EXPLOSION AND PERSONAL INJURY. READ ANSI-B40.1 AND APPARATUS INSTALLATION/OPERATION MANUALS BEFORE USING.

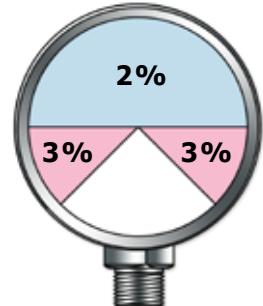

ANSI GRADE B

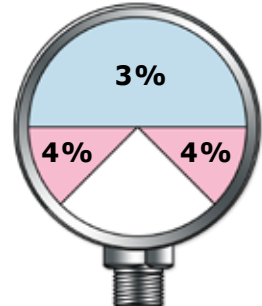

ANSI GRADE C

# How To Order



## GAUGE ORDER NUMBER MATRIX

**SSG**

**25**

**0**

**2**

-

**1.5K**

**10** = 1"  
**15** = 1-1/2"  
**20** = 2"  
**25** = 2-1/2"  
**35** = 3-1/2"  
**40** = 4"  
**45** = 4-1/2"

**0** = Back  
**1** = Bottom

**1** = 1/8" NPT  
**2** = 1/4" NPT  
**4** = 1/2" NPT  
(only available in  
4" & 4.5" Dial  
Diameter)

**PAD** = PLASTIC CASE **ACRYLIC** LENS **DRY**  
**SAD** = STEEL CASE **ACRYLIC** LENS **DRY**  
**SGD** = STEEL CASE **GLASS** LENS **DRY**  
**SSG** = STAINLESS STEEL CASE **GLYCERINE** FILLED  
**SPM** = STEEL CASE **PANEL** MOUNT **DRY**  
**LSS** = LIQUID FILLED ALL **STAINLESS STEEL**  
**SSAD** = ALL **STAINLESS STEEL** **ACRYLIC** LENS **DRY**  
**DPG** = **DRY** PROCESS **GAUGE** (FILLABLE)

**V** = 30 HG-0  
**C** = 30 HG-0-30  
**15** = 0-15  
**30** = 0-30  
**60** = 0-60  
**100** = 0-100  
**200** = 0-200  
**300** = 0-300  
**400** = 0-400  
**500** = 0-500  
**600** = 0-600  
**1K** = 0-1000  
**1.5K** = 0-1500  
**2K** = 0-2000  
**3K** = 0-3000  
**5K** = 0-5000  
**6K** = 0-6000  
**10K** = 0-10000  
**15K** = 0-15000



# Dry Gauges



Center-Back Mount



Bottom Mount

- ## Features:
- Utility Gauges for Commercial and Industrial Markets
  - Black Steel Case with Chrome Bezel
  - Copper Alloy Internals
  - Available with Stainless Steel Case
  - Certificate of Accuracy, NIST Traceable C/F
  - Temperature Range -50°F to 160°F

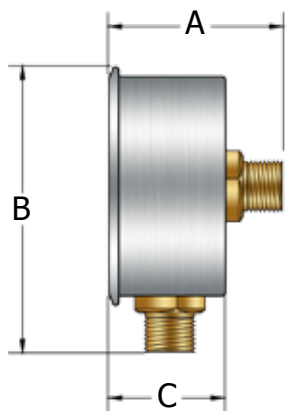

CBM = Center Back Mount  
LM = Lower Mount

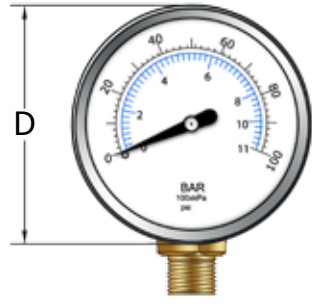

## Dimensions

Face Size	Connection	A (CBM Only)	B (LM Only)	C	D
1"	1/8" NPT		n/a	.64/16mm (n/a)	.99/25mm (n/a)
1-1/2"	1/8" NPT	1.54/39mm	2.26/57mm	.93/24mm	1.64/42mm
2"	1/8" or 1/4" NPT	1.90/48mm	2.83/72mm	1.03/26mm (1.06/27mm)	2.07/53mm
2-1/2"	1/4" NPT	1.97/50mm	3.31/84mm	1.17/30mm (1.13/29mm)	2.50/63mm
3-1/2"	1/4" NPT	2.02/51mm	4.49/114mm	1.22/31mm (1.12/28mm)	3.49/89mm (3.53/90mm)
4-1/2"	1/4" or 1/2" NPT	2.18/55mm	5.80/147mm	1.31/33mm (1.12/29mm)	4.50/114mm (4.79/122mm)

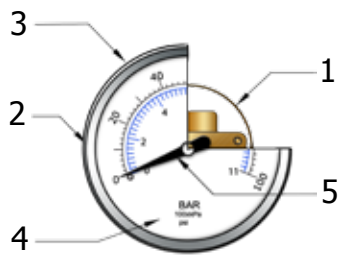

## Bill of Materials

No.	Part	Material
1	Internals	Copper Alloy
2	Case	Black, Steel
3	Bezel	Chrome Plated Steel
4	Lens	Plastic
5	Pointer	Black, Aluminum

# Glycerin Filled Gauges



Bottom Mount

Center-Back Mount



## Features:

- Glycerin Filled for added Durability and Vibration
- Stainless Steel Case and Bezel
- Copper Alloy Internals
- Certificate of Accuracy, NIST Traceable C/F
- Temperature Range 30°F to 160°F

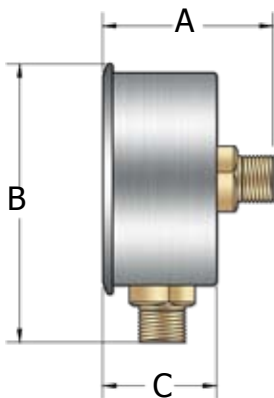

CBM = Center Back Mount  
LM = Lower Mount

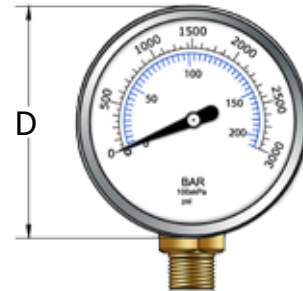

## Dimensions

Face Size	Connection	A (CBM Only)	B (LM Only)	C	D
1-1/2"	1/8" NPT	1.74/44mm	2.28/58mm	1.02/26mm (1.00/25mm)	1.85/47mm
2"	1/8" or 1/4" NPT	2.08/53mm	2.95/75mm	1.18/30mm (1.20/31mm)	2.28/58mm
2-1/2"	1/4" NPT	2.28/58mm	3.55/90mm	1.34/34mm (1.40/36mm)	2.80/71mm
4"	1/4" or 1/2" NPT	3.15/80mm	5.21/132mm	1.16/29mm (1.75/45mm)	4.29/109mm

## Bill of Materials

No.	Part	Material
1	Internals	Copper Alloy
2	Case	Stainless Steel
3	Bezel	Stainless Steel
4	Lens	Polycarbonate
5	Pointer	Black, Aluminum

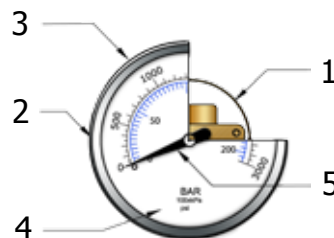



# Panel Mount Gauges



- ### Features:
- Utility Gauges for Commercial and Industrial Markets
  - Chrome Plated Steel Case and Bezel
  - Copper Alloy Internals
  - Certificate of Accuracy, NIST Traceable C/F
  - Temperature Range -50°F to 160°F

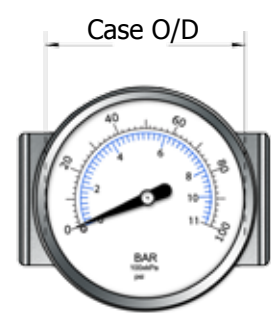
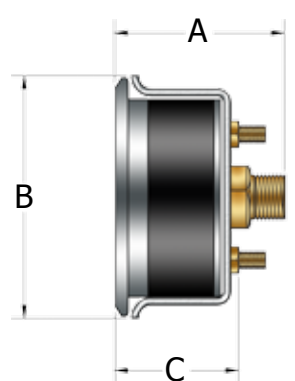

## Dimensions

Size	Connection	A	B	C	Case O/D
1-1/2"	1/8" NPT	1.61/41mm	1.84/47mm	1.03/26mm	1.61/41mm
2"	1/8" or 1/4" NPT	1.84/47mm	2.31/59mm	1.18/30mm	2.04/52mm
2-1/2"	1/4" NPT	1.87/48mm	2.68/68mm	1.12/28mm	2.44/62mm
3-1/2"	1/4" NPT	2.02/51mm	3.98/101mm	1.23/31mm	3.59/91mm

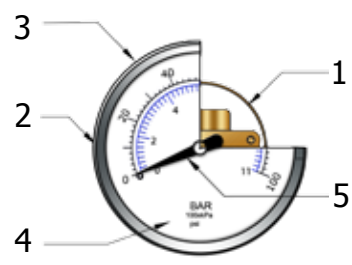

## Bill of Materials

No.	Part	Material
1	Internals	Copper Alloy
2	Case	Chrome Plated Steel
3	Bezel	Chrome Plated Steel
4	Lens	Plastic
5	Pointer	Black, Aluminum

# DPG Process Gauges



## Features:

- Solid Front Blow-Out Back Safety Case
- Field Liquid Fill-able
- 316 Stainless Steel Internals
- Certificate of Accuracy, NIST Traceable C/F
- Temperature Dry -30°F to 160°F
- Temperature Glycerine Filled 30°F to 160°F

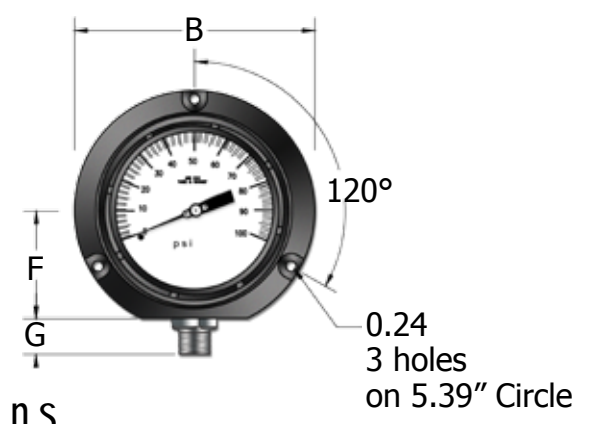
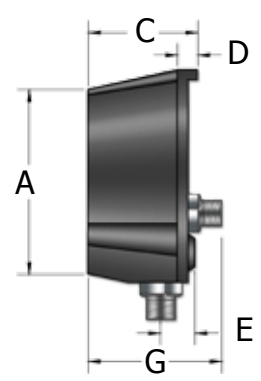

## Dimensions

Connection	Face	A	B	C	D	E	F	G	NPT
Back	4-1/2"	5.08	5.84	3.44	1.10	-	2.54	4.27	1/2"
Bottom	4-1/2"	5.07	5.91	3.03	0.91	1.38	2.56	1.38	1/4"

## Bill of Materials

No.	Part	Material
1	Internals	Stainless Steel
2	Case	Phenolic Case
3	Lens	Polycarbonate
4	Pointer	Black, Aluminum

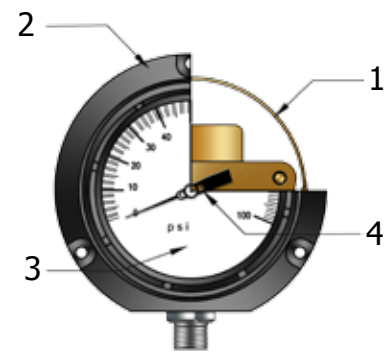

**Universal  
Components  
Inc.**



1313 Hall Spencer Road  
Rock Hill, S.C. 29730

Phone: 803-324-5176  
Fax: 803-324-2640

[www.ucimfg.com](http://www.ucimfg.com)  
[sales@ucimfg.com](mailto:sales@ucimfg.com)